

<h1>LABEL</h1>					
Centre No.					
Candidate No.					

Surname(s)	First name(s)
Signature	

**December 2018**

Time: 1 hour 35 minutes	Paper Reference(s) <b>4061/01</b>
-------------------------	-----------------------------------

**Pearson Test of English**  
**General**  
**Level 1**

<b>Materials required for examination</b>	<b>Items included with question papers</b>
CD player 1 CD per 10 Candidates	Nil

Examiner's use only	
Team Leader's use only	
Question Number	Leave Blank
1	
2	
3	
4	
5	
6	
7	
8	
9	
<b>Total</b>	

**Instructions to Candidates**

- Your candidate details:
  - Step 1: Write your surname(s), first name(s) and signature in the boxes at the top right of the page.
  - Step 2: – If you have been given a label containing your details then stick it carefully in the box at the top left of the page.  
– If you have not been given a label, then write your centre number and candidate number in the boxes at the top left of the page.
- Do not use pencil. Use blue or black ink. Some tasks must be answered with a cross in a box ☒. If you change your mind about an answer, put a line through the box ☒ and then mark your new answer with a cross ☒.
- Answer ALL the questions. Write your answers in the spaces provided in this question paper.

**Information for Candidates**

- The marks for the various tasks are shown in round brackets: e.g. (10 marks).
- There are 9 sections in this question paper. The total mark for this paper is 75.
- There are 20 pages in this question paper. Any blank pages are indicated.

**Advice to Candidates**

- Write your answers neatly.

This publication may be reproduced only in accordance with Pearson Education Ltd copyright policy.

S63529A

©2018 Pearson Education Ltd.

1/1/



Turn over ▶



Pearson

This is the Pearson Test of English General Level 1. This test takes 1 hour and 35 minutes.

Section 1

You have ten seconds to read each question. Listen and put a cross ☒ in the box next to the correct answer, as in the example. You have ten seconds to choose the correct option.

Example: What does Anna want to buy?

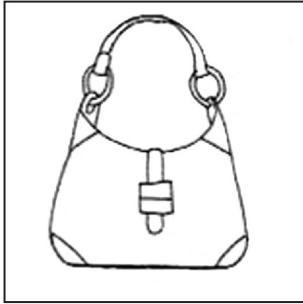

A ☒



B ☒

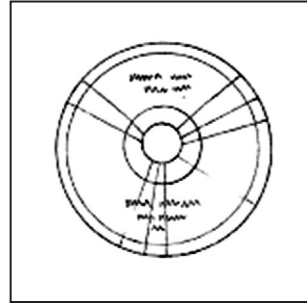

C ☒

1 What is Julia going to do that morning?



A ☒



B ☒



C ☒

1

2 What is Mr Hammond's job?



A ☒

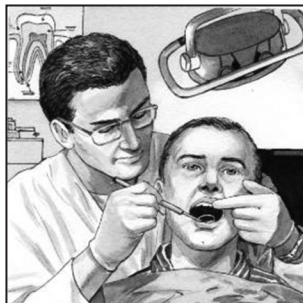

B ☒

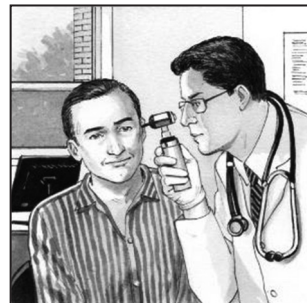

C ☒

2

DO NOT WRITE IN THIS AREA

DO NOT WRITE IN THIS AREA

DO NOT WRITE IN THIS AREA



S 6 3 5 2 9 A 0 3 2 0

3 Where's the book?

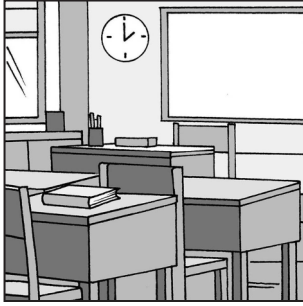

A

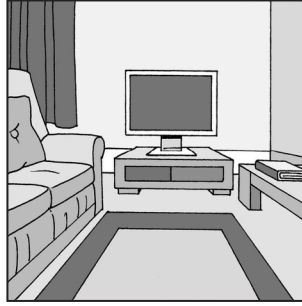

B

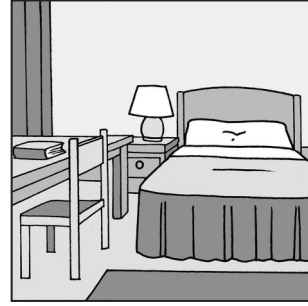

C

3

4 Where's the woman?



A



B



C

4

5 What are the speakers doing?



A

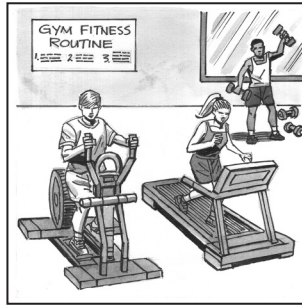

B



C

5

6 Which is the correct picture?

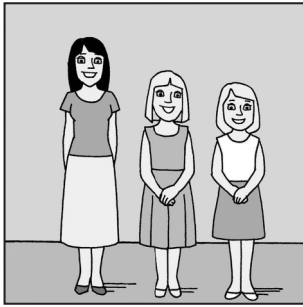

A

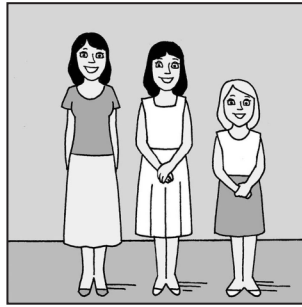

B

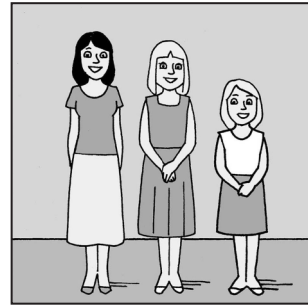

C

6

DO NOT WRITE IN THIS AREA

DO NOT WRITE IN THIS AREA

DO NOT WRITE IN THIS AREA



7 Where is the sandwich?



A

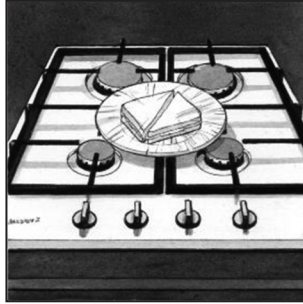

B

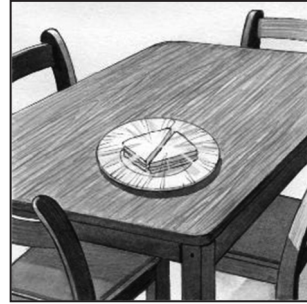

C

7

8 Which man is the bride's father?



A



B



C

8

9 What time is the baseball game?

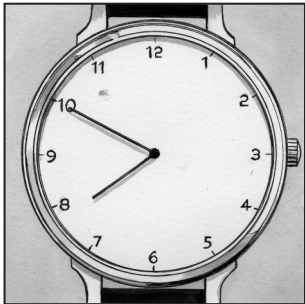

A

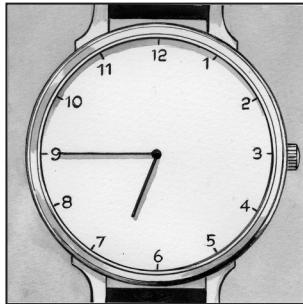

B

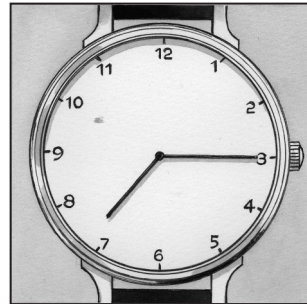

C

9

10 What is John going to put in the back of the car?

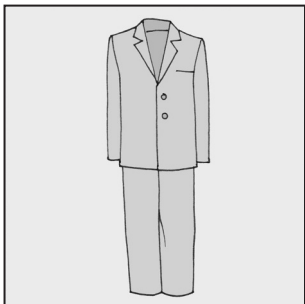

A

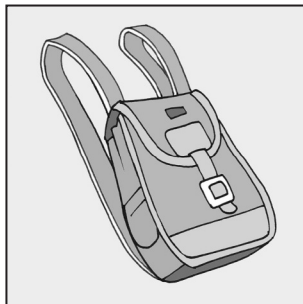

B

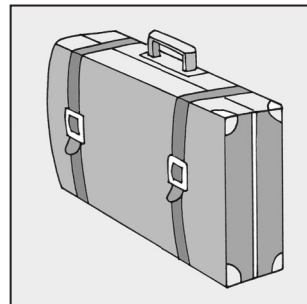

C

10

Section 1

(Total 10 marks)



DO NOT WRITE IN THIS AREA

DO NOT WRITE IN THIS AREA

DO NOT WRITE IN THIS AREA



DO NOT WRITE IN THIS AREA

DO NOT WRITE IN THIS AREA

DO NOT WRITE IN THIS AREA

Leave blank

**Section 3**

**12-16** You will hear a telephone message. First, read the notes below then listen and complete the notes with information from the telephone message. You will hear the recording twice.

The Ark

**Example:** Name of vet's: .....

12

**12** Telephone number: .....

13

**13** Morning opening: 8.30 till .....

14

**14** Dog's name: .....

15

**15** Best time for appointment: .....

16

**16** If today send: .....

**17-21** You will hear a recorded message. First, read the notes below then listen and complete the notes with information from the message. You will hear the recording twice.

Dave

**Example:** Call from: .....

17

**17** Problem with computer: .....

18

**18** Time to meet: .....

19

**19** Location of restaurant: .....

20

**20** Name of restaurant: .....

21

**21** Phone back: .....

**Section 3**

(Total 10 marks)

**That is the end of the listening section of the test. Now go on to the other sections of the test.**



**Section 4**

Read each section of the test and put a cross  by the missing word or phrase, as in the example.

**Example:**

Sightseeing tours depart from the bus station on the hour  
..... from 10.00 to 18.00. Tickets – \$20 for adults and \$10 for children.

- A sometimes
- B every hour
- C in the mornings

**22**

Music Room Rules  
No food or drink.  
No running.  
Be quiet while others are .....  
Take good care of your instrument.

- A eating
- B practicing
- C writing

22

**23**

Gino's Restaurant  
We are looking for the following staff:  
Manager  
Cook  
.....  
Cleaner

- A Waiter
- B Customer
- C Shop assistant

23

**24**

Motorists. Please switch off your car engine before you .....  
the pumps.

- A fill up
- B use
- C work

24

DO NOT WRITE IN THIS AREA

DO NOT WRITE IN THIS AREA

DO NOT WRITE IN THIS AREA



DO NOT WRITE IN THIS AREA

DO NOT WRITE IN THIS AREA

DO NOT WRITE IN THIS AREA

Leave blank

25 Dear parents, we have a class ..... next Wednesday. We're going to the museum. Your child needs to bring a drink and a snack.

- A teacher
- B visit
- C lesson

25

26 Training for a marathon? Don't do those long runs alone. Join our marathon training group today! Beginning in April, we will ..... every Saturday.

- A work
- B win
- C meet

26

Section 4

(Total 5 marks)





Section 5

For each question, put a cross ☒ in the box below the correct picture, as in the example.

Example:

'The Desert' by Jane Green is the latest of her wonderful films set in Africa. It's on at the Regal until the end of this week but after that you'll have to go to the Majestic. Or of course you can rent the DVD from The Film Centre.

Which cinema is showing 'The Desert' next week?



A



B



C

27

Hi Joe

We're moving to the new office on Monday and I'm away, so can you move my stuff for me? Put my plant and diary on the bottom shelf, books on the middle shelf, and all the stationery on the top one.

Thanks – Lynn

Which is the correct picture?

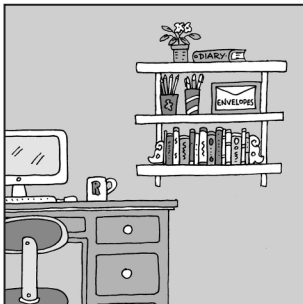

A

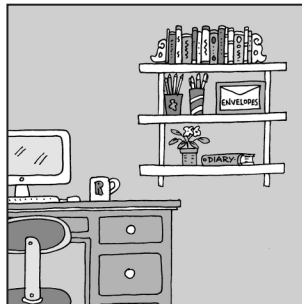

B

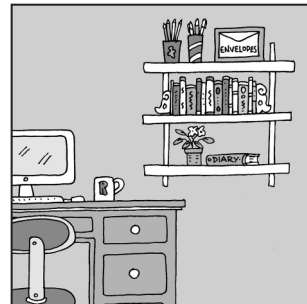

C

DO NOT WRITE IN THIS AREA

DO NOT WRITE IN THIS AREA

DO NOT WRITE IN THIS AREA

27



DO NOT WRITE IN THIS AREA

28 Hi Karen, thanks for my birthday present. I really wanted that book. I got some other presents too. A new phone and some fantastic sunglasses. I wanted a new laptop but my parents got me a bike instead. See you soon. Eva.

Which picture shows Eva's presents?



A



B



C

28

DO NOT WRITE IN THIS AREA

29 **Super Food for All**

Everyone can eat the right foods – not just sportspeople! For example, strawberries help you remember things. For vitamin C eat an orange every day. Oily fish such as salmon help your heart. Eat lots of nuts because they are good for your memory.

Which two foods help your memory?

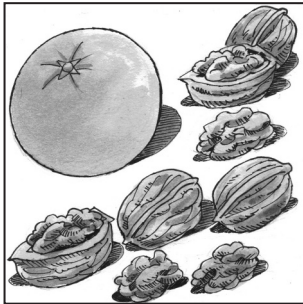

A

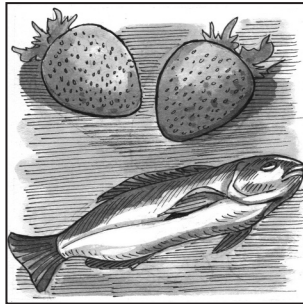

B

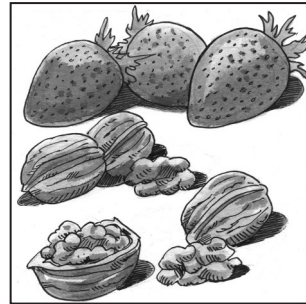

C

29

DO NOT WRITE IN THIS AREA



S 6 3 5 2 9 A 0 1 1 2 0

**30 TV Guide**

Performing tonight on the Andrew Miller Show, Mr. Steve Edinburgh. Steve has been performing for fifty years. He has done ten world tours. Watch Andrew Miller's interview with Mr. Steve Edinburgh after tonight's news.

Which picture shows the correct TV guide?

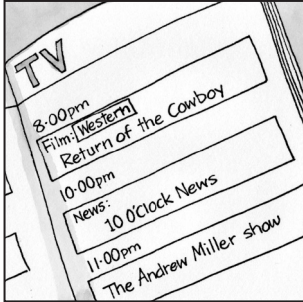

**A**

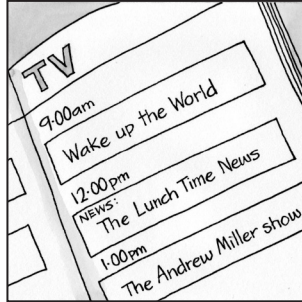

**B**

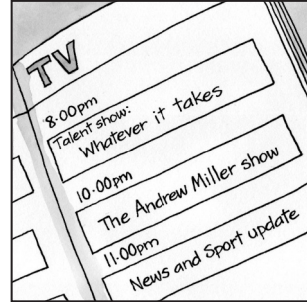

**C**

30

**31 Hi Alice,**

We're enjoying life here in Australia. Dave isn't working as a teacher now. He's got a job at Melba Bank and is really enjoying it. It's very convenient because I work in the shoe shop next door!

Write soon,  
Carly XX

Where does Dave work?



**A**



**B**

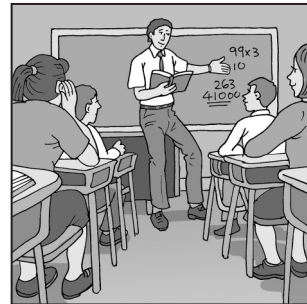

**C**

31



**Section 6**

Read the text below and answer the questions.

You can visit Berry Castle in the small town of Berrisford. It was built eight hundred years ago and it is in very good condition today. The castle is open to visitors from 1st April to 31st October. There is no car park for Berry Castle but you can use the town centre car park. This year, for the first time, a restaurant is now open in the gardens of the castle. Castle entry £10.00. Half price for children under 14.

**Example:** Where is Berry Castle? ..... Berrisford .....

32

**32** How old is it? .....

33

**33** From the beginning of which month is the castle closed? .....

34

**34** Where can you park? .....

35

**35** What is new this year? .....

Read the hotel notice below and answer the questions.

The Regent Hotel invites all guests to a New Year's party in the dining room tonight. The party starts at 8pm and with live music and dancing from 10pm you can have fun until 12.30am. There will be free food but guests will need a special card for soft drinks. Guests can buy these cards from the reception after 3pm. The entertainment includes a singing competition at the end of the evening. Hope you can come.

Hotel Manager

**Example:** Where in the hotel is the New Year's party? ..... the dining room .....

36

**36** What time does the entertainment start? .....

37

**37** What can guests get without paying for it? .....

38

**38** Where can guests get a card for drinks? .....

39

**39** What will happen before the end of the party? .....

**Section 6**

**(Total 8 marks)**



DO NOT WRITE IN THIS AREA

DO NOT WRITE IN THIS AREA

DO NOT WRITE IN THIS AREA

**Section 7**

Read the brochure and complete the notes. Write **no more than three words** from the text in each gap from the brochure.

**Visiting Buntleigh Castle and Gardens**

Buntleigh Castle and gardens are open from April to October. The castle is home to one of the world's largest collections of butterflies. Children's attractions include an adventure playground and model railway. There is a lot to see and do, so we suggest you allow about 4 hours for your visit.

On the lake, boats are available for hire from 12am until 4pm, and cost £10. Please note that on 20th August there will be no boats for hire as the lake is being used for a film shoot.

Audio Guides are available from the Ticket Office in English or French. Price £4.00.

**Other information**

Toilets are situated at the Lakeside Restaurant. Parking is £2.50 per vehicle. Photography is not allowed in the castle, but is permitted in the gardens. Dogs are permitted in the grounds.

**Example:** Name of Castle ..... Buntleigh .....

**40** Earliest month you can visit the castle .....

**41** Suggested time you spend in the castle .....

**42** Price of boat hire .....

**43** When is the lake closed to the public .....

**44** Where you can get an audio guide .....

**45** Cost to park your car .....

**46** Photography is allowed .....

40

41

42

43

44

45

46

**Section 7**

**(Total 7 marks)**

DO NOT WRITE IN THIS AREA

DO NOT WRITE IN THIS AREA

DO NOT WRITE IN THIS AREA



### Section 8

Use the information in **Section 7** to help you write your answer. **Use your own words.**

**47** You have read the brochure about Buntleigh Castle. Now write an email to a friend. **Write 50–70 words** and include the following information:

- tell him/her about Buntleigh Castle
- tell him/her what you can do there
- suggest that you go to visit the castle together

.....

.....

.....

.....

.....

.....

.....

.....

.....

.....

.....

.....

.....

.....

.....

.....

.....

.....

.....

.....

.....

.....

.....

.....

.....

.....

47E

47F

47R

47A

47C

47OC

47WI

Section  
8

--	--

(Total 10 marks)

DO NOT WRITE IN THIS AREA

DO NOT WRITE IN THIS AREA

DO NOT WRITE IN THIS AREA



Section 9

48 Choose **one** of the topics below and write your answer in **80–100 words**.

**Either:**

**A** You helped your neighbour last Saturday. Write a story about what happened.



**Or:**

**B** Jessie is your friend. He had some trouble walking his dog. Look at the pictures and write a short story about how he solved his problem.

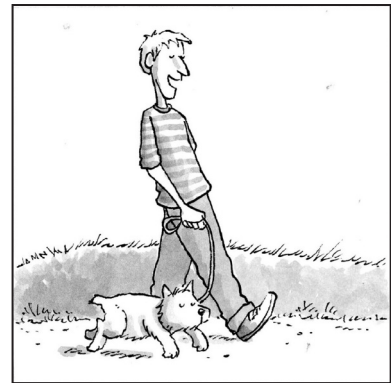
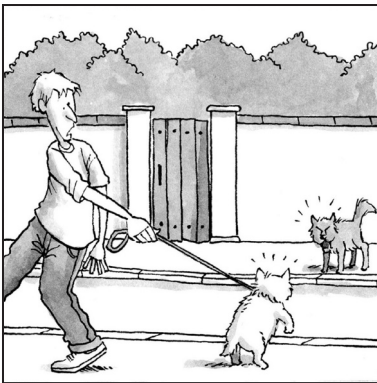

Put a cross  in the box next to the task you have chosen.

**A**

**B**

.....  
.....  
.....  
.....  
.....  
.....  
.....  
.....  
.....

DO NOT WRITE IN THIS AREA

DO NOT WRITE IN THIS AREA

- 48E
- 48F
- 48R
- 48A
- 48C
- 48OC
- 48WI

DO NOT WRITE IN THIS AREA



DO NOT WRITE IN THIS AREA

DO NOT WRITE IN THIS AREA

DO NOT WRITE IN THIS AREA

Area with horizontal dotted lines for writing.

Section 9

(Total 10 marks)

THAT IS THE END OF THE TEST

